

PH Aviation Services, Inc.
Flap Actuator
p/n PHA-09P (Suitable for the RV-10 & 14)
Installation & Operating Instructions

SPECIFICATIONS:

Input Voltage: 12 VDC
Current: 4A at full load
Load Capacity: 150 pounds
Stroke length: 5 inches
Speed: Approximately 0.4 inch per second
Internal Limit Switches: Full stop at ends
Potentiometer: Built in position sensing
Hole to Hole Length: 11 $\frac{3}{4}$ " (Retracted)
Weight: 2 lbs. 15 oz. (+1 lb. 5 oz. over stock actuator)

Overview – The PHA-09P Flap Actuator was developed to be an improvement over the standard actuator found in the larger RVs. It has the same stroke and speed as the stock RV-10 and -14 flap motors; however, it has built-in stops and an internal potentiometer that can transmit the flap position to an indicator or EFIS display. Because it comes to a complete stop at both extremes, there is no need for the safety-wire bulletin that is mandatory in the stock actuators. Furthermore, external flap limit switches are not necessary to stop the flap motor, so you can use a locking control switch for the UP position thus avoiding the use of the spring-loaded position to raise the flaps. You can just flip your flap switch to the UP position and forget about it! It is also possible to easily use the actuator with a flap positioning system such as the Garmin GAD 27.

It should prove to be extremely reliable. We have installed two test units in RV-10s and are pleased with the results we've seen. These actuators are made for us by a reputable manufacturer to our spec and we believe them to be top quality.

Installation – the PHA actuator is not a drop-in replacement for the stock RV actuator. It is actually about 1.5" longer and a little taller, so it will require some modification to your current installation. We consider the changes to be minor, however. Following is a detailed description of the installation of the PHA actuator in one of our test RV-10s. Your airplane may vary.

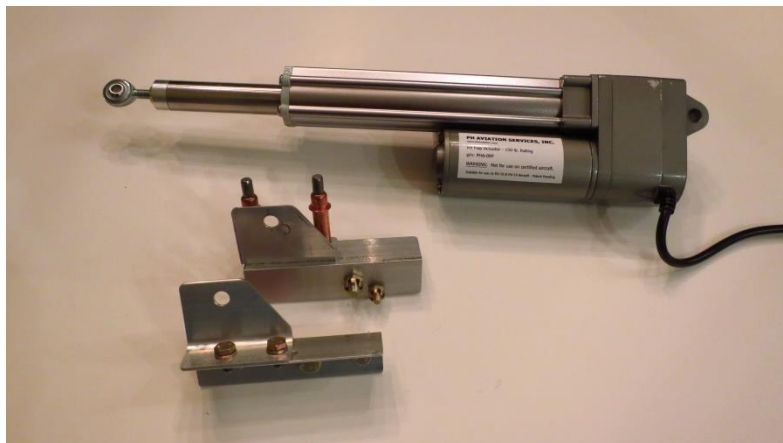

In the picture above, we show you the brackets that we fabricated next to the new PHA flap actuator. We made these brackets out of 1 ½ X 1 ½ X 0.063", 2024 T3 as shown in the drawing on the next page. The idea is to be able to mount the new actuator about 1 ½" forward of the stock position to allow for the additional length of the new actuator. These brackets mount on top of the existing brackets to allow the new mount position to move forward sufficiently. Make sure that the rod end bearing is adjusted properly so that the actuator does not interfere with the flap weldment at the rear attach point. You may need to adjust the new mounts slightly to allow for differences in your particular airplane. Best to trial fit everything with clecos prior to drilling the final holes. We replaced the existing left-hand bracket with the more robust one shown in the picture above.

We used a 1/8" round file to slot the forward flange of the existing mount where the new brackets would otherwise interfere with this flange. We used an AN5-23 bolt to mount the new actuator. This bolt is the proper length for the new brackets. You will have to make up some spacers for this bolt as shown in the attached photos.

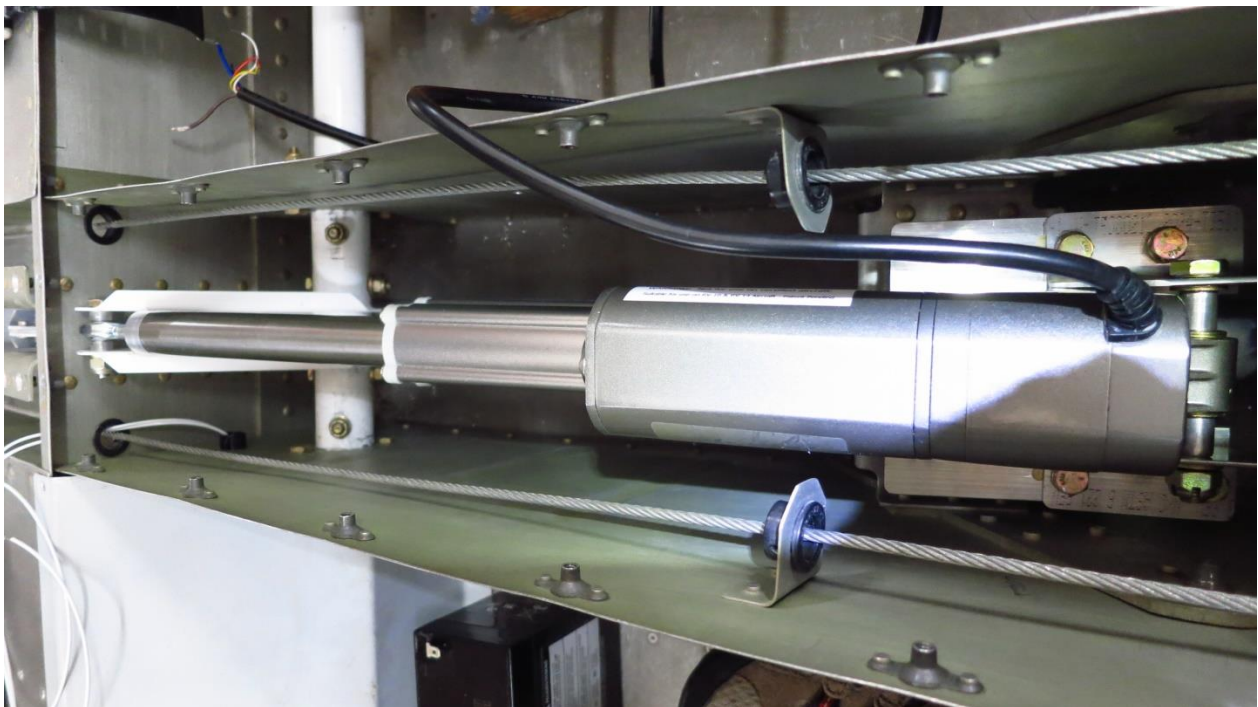
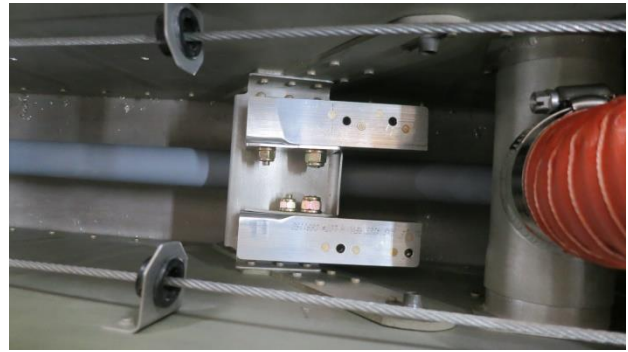
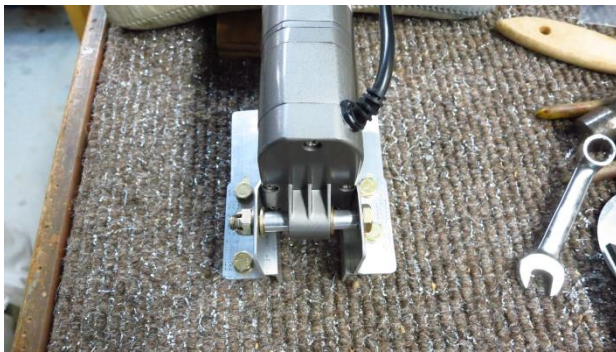

Following is a drawing detailing the new brackets that we made for the RV-10:

RV-10 Add-on Bracket for RV-10/-14 Flap Actuator

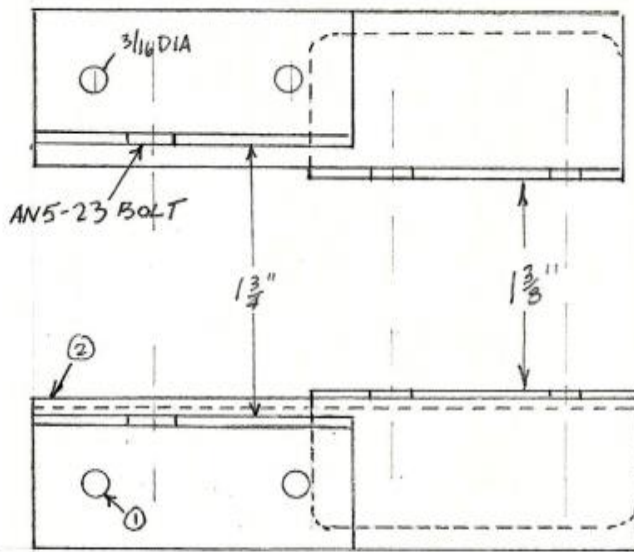

TOP VIEW

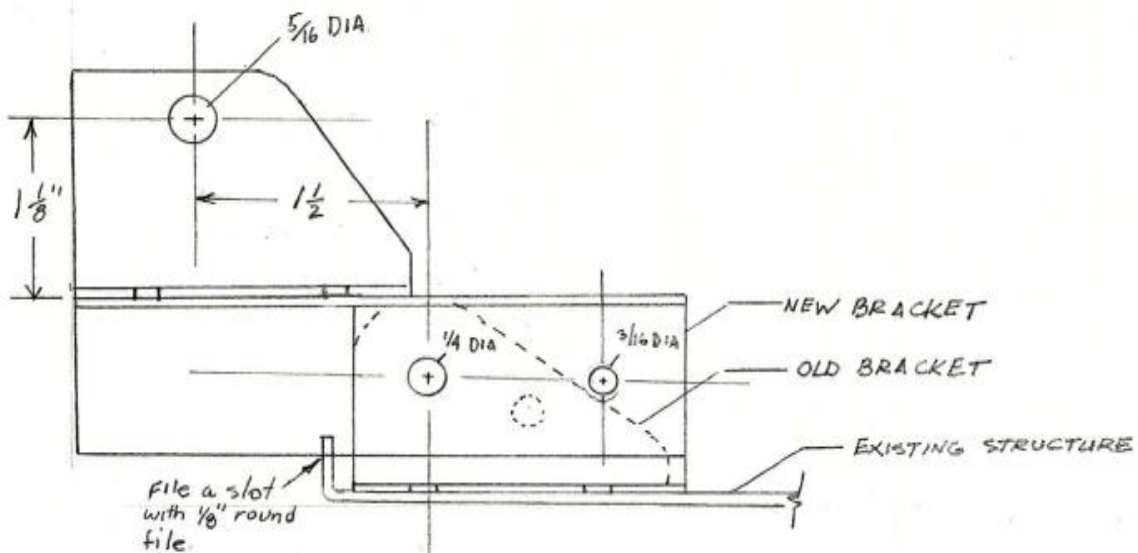
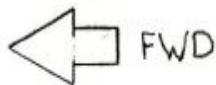

SIDE VIEW

NOTES:

- ① install #10 nutplates - 4 places
- ② relieve bracket corner as necessary. (see photos)

Drawn to Scale

CAUTION – CAUTION – CAUTION

To protect your actuator from damage please observe the following precautions: do not allow your motor to stall for any reason—internal damage may result! Make sure your flap assembly moves smoothly throughout its range without binding. Make sure that there is no interference between the actuator and its bracket or any part of the airplane structure. And, finally, make sure that the flaps don't reach the end of their travel before the motor stops—to do so will cause the motor to stall and possibly strip internal gears. Adjust the flaps so that the actuator reaches its stops just prior to, or simultaneously with, the flaps' physical stops; for example, the flaps touching the bottom of the fuselage when they are fully up.

Electrical Hookup – The preferred wiring method for the PHA Flap Actuator is through a relay deck. However, the existing wiring in your airplane will work just fine. The advantage of using relays is that only a few milliamps go through your flap switch, which will allow you're switch to last a very long time. Otherwise, if the full load of the flap motor goes through your switch (up to 5 amps), it will result in a diminished switch life. You will probably want a switch that locks UP and spring loads DN. When the flap actuator gets to the end of its stroke, the flaps stop. The brown and blue wires are the motor power inputs. We recommend a 10 amp breaker.

Flap position indicators – the pot inside the actuator is a standard setup much like is found in the conventional trim actuators in your airplane. There are two reference wires (white and yellow), and the red wire is the signal (wiper). In our Garmin GEA 24 hookup, the yellow wire connects to the 5v excitation voltage, the white wire to LO, and the red wire to the signal input. Be sure to recalibrate your indicator for the new sensor.

If you have any questions, please email us at pat@phaviation.com.

Thanks for purchasing our product!

Disclaimer & Warranty:

This part was manufactured by PH Aviation Services, Inc. and should NOT be installed in Certified Aircraft. It is intended for use only in Experimental Aircraft and to be installed by the builder. There are no warranties expressed or implied and purchaser assumes all risk for the operation of this part. However, the purchaser may return this part for repair, replacement, or a full refund if it fails to operate as intended at any time during the first 12 months after the date of purchase.

Return Policy

Normally we accept returns only if the part fails to perform as advertised. We will consider a request for a return on an individual case basis, and, if we agree to accept a return, we will charge for shipping costs and a 10% restocking fee.